

TECHNICAL FILE

# Occasional tables

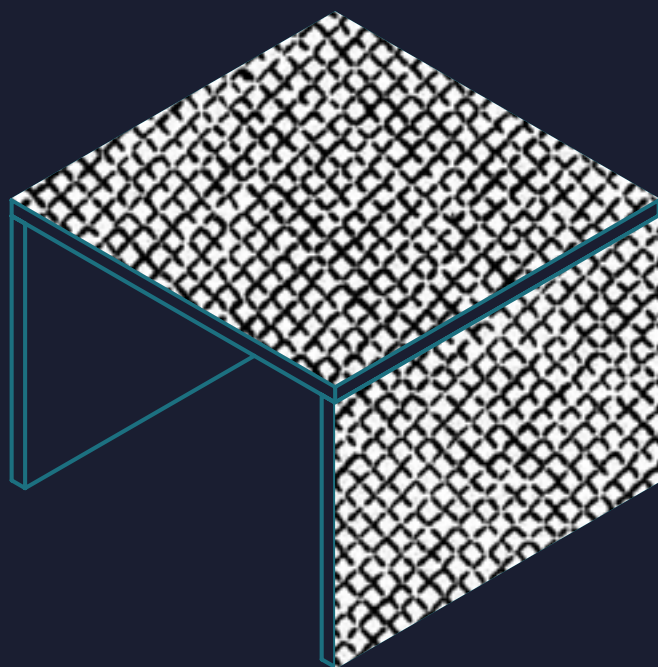

BOS  
BARCELONA  
— SINCE 1964 —

Occasional tables  
**TECHNICAL FILE**

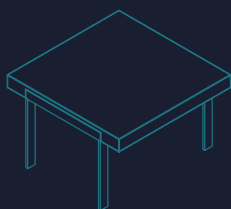

AVOCADO



AQUA

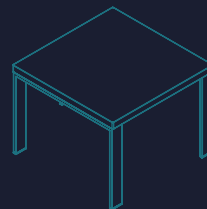

ODESSA



LEAD PLUS

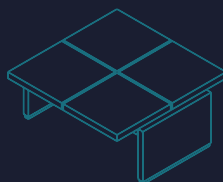

KARAN

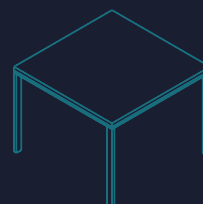

FORO

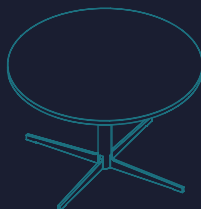

X64

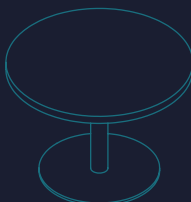

RODA

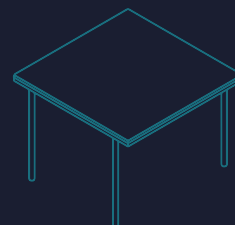

LA SCALA

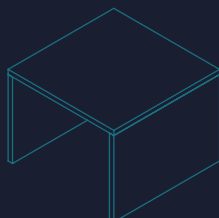

LEAD

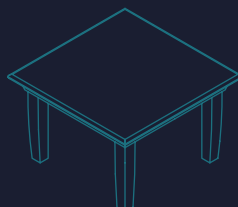

AVANT

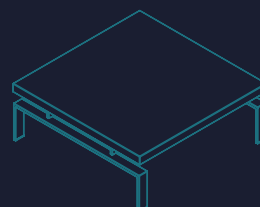

LEAD

## Materials, Finishes & Quality

- Table top core is MDF Mediland quality LP classified as Class E1 according to European norm EN 622-1:2003 and density between 600-620KGS/m<sup>3</sup> which is maximum in furniture appliance.
- To achieve the piano lacquer finish a thick layer of lacquer is applied which afterwards goes through a 10 years manual polishing process with wool.
- All pieces come with three layers of polish with **sanding by hand** between each layer to achieve an optimal smooth adherence and durability.
- The wooden parts are all **polished** with lacquers of polyurethane with high content of solids to build a greater hardness without losing the sensation of the wooden touch.
- The decorating elements are made by **laser cut stainless steel** finished by hand.
- The structures are made of steel given an **exclusive treatment** which consist of niquel bath, lacquered and polished by hand.
- All tables are **finished by hand**, pre-assembled in the factory, numbered one by one to guarantee a perfect assembly for the final client.
- **Unique packaging** in reticulated polyethylene foam, triple layer of laminate polyethylene with hermetic bubbles 5x5 and density of 5400 bubbles/m<sup>2</sup>, corner protectors of high density reticulated polyethylene foam and cardboard box made to fit.



UNE-EN ISO  
9001:2015

UNE-EN ISO  
14001:2015

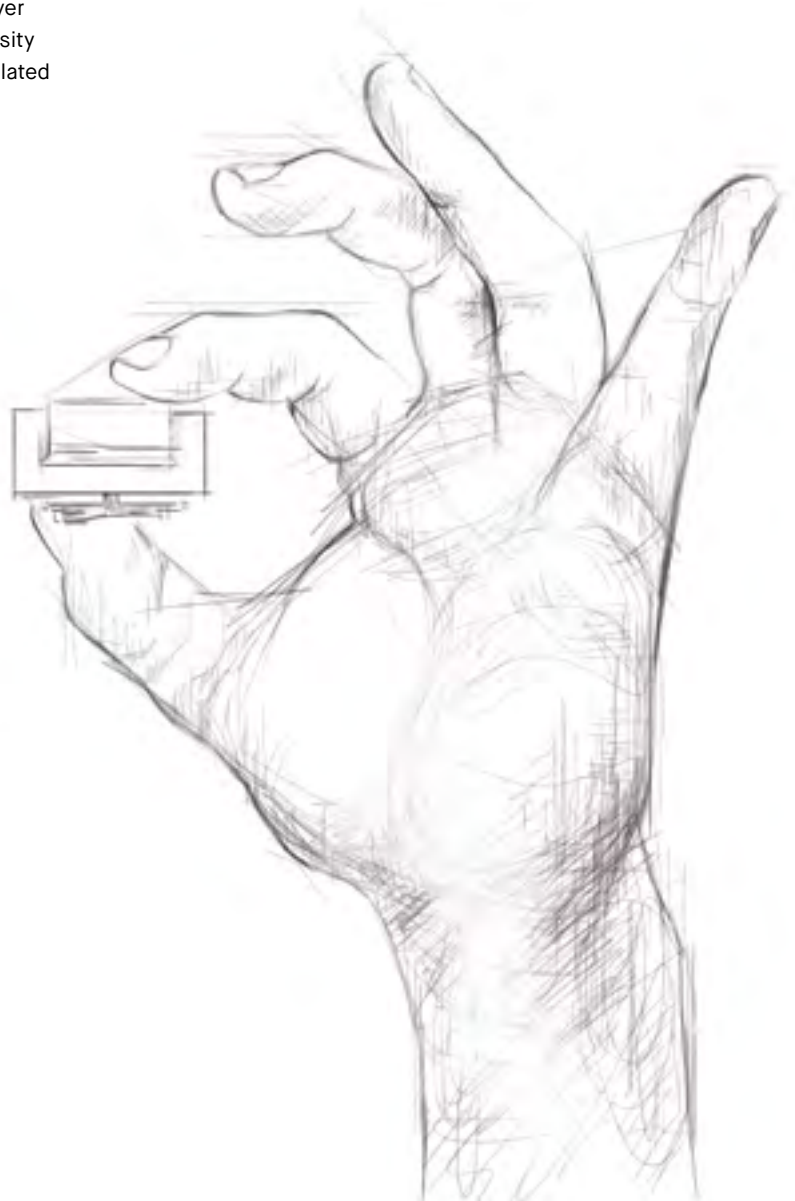



# AVOCADO

## TECHNICAL PRESENTATION

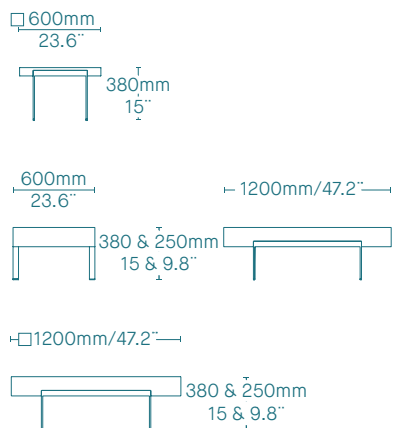
### Dimensions



### Table top

Thickness	Shape	Finishes
140mm 5.5"		Wood Lacquer
60mm 2.4"		

### Structure

Shapes	Finishes
	Chromed





# AQUA

## TECHNICAL PRESENTATION

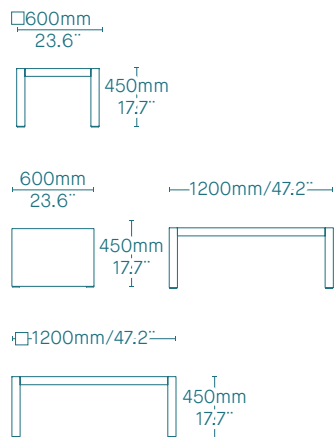
### Dimensions



### Table top

Thickness	Shape	Finishes
60mm 2.4"		Wood Lacquer Leather
		

### Structure

Thickness	Shapes	Finishes
60mm 2.4"		Wood Lacquer



# ODESSA

## TECHNICAL PRESENTATION

### Dimensions

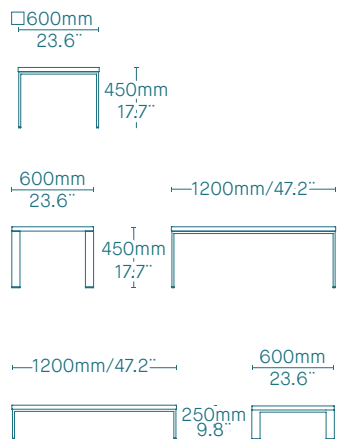

### Table top

Thickness	Shape	Finishes
35mm 1.4"		Wood Lacquer Matt glass

### Structure

Shapes	Finishes
	Stainless steel





# LEAD PLUS

## TECHNICAL PRESENTATION

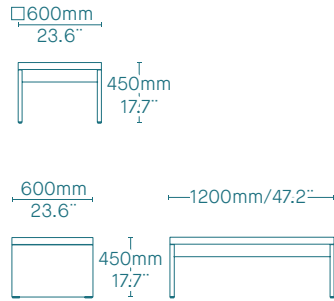
### Dimensions



### Table top

Thickness	Shape	Finishes
50mm 2"	 	Wood

### Structure

Shapes	Finishes
	Wood





# KARAN

## TECHNICAL PRESENTATION

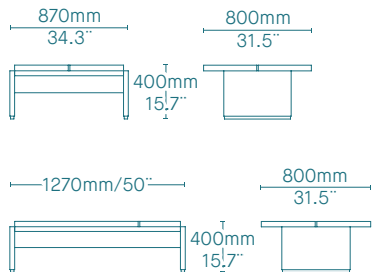
### Dimensions



### Table top

Thickness	Shape	Finishes
60mm 2.4"		Wood
		

### Structure

Shapes	Finishes
	Lacquer





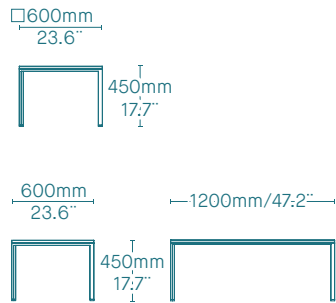

# FORO

## TECHNICAL PRESENTATION

### Dimensions



### Table top

Thickness	Shape	Finishes
 19mm 0.9"		Wood Matt glass
 5+5mm 0.2+0.2"		

### Structure

Shapes	Finishes
	Chromed



x64

## TECHNICAL PRESENTATION

### Dimensions

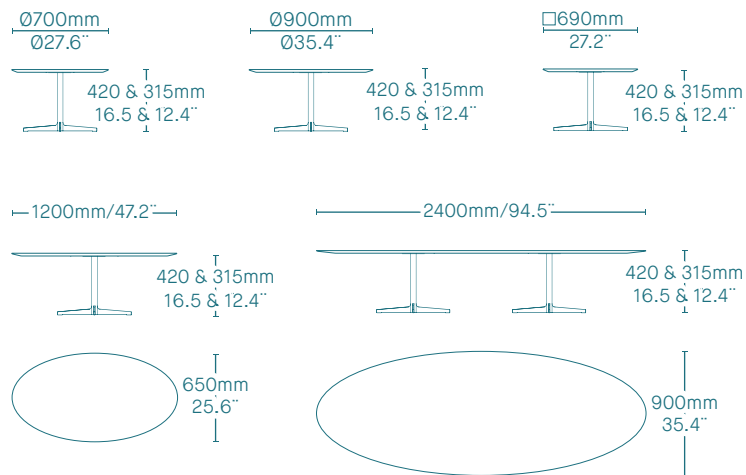

### Table top

#### Thickness



#### Shape



#### Finishes

Wood  
Lacquer

### Structure

#### Shapes



#### Finishes

Chromed





# RODA

## TECHNICAL PRESENTATION

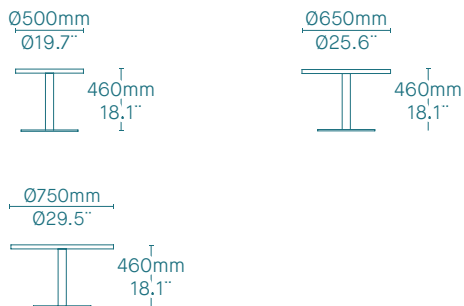
### Dimensions



### Table top

Thickness	Shape	Finishes
 19mm 0.9"		Wood Lacquer

### Structure

Shapes	Finishes
	Chromed





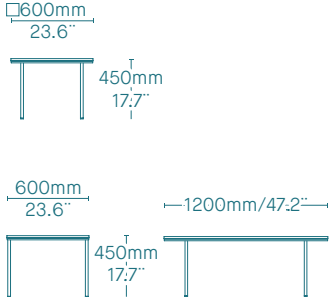

# LA SCALA

## TECHNICAL PRESENTATION

### Dimensions



### Table top

Thickness	Shape	Finishes
 20mm 0.8"		Wood Lacquer Matt glass
 5+5mm 0.2+0.2"		

### Structure

Shapes	Finishes
	Chromed



# LEAD

## TECHNICAL PRESENTATION

### Dimensions

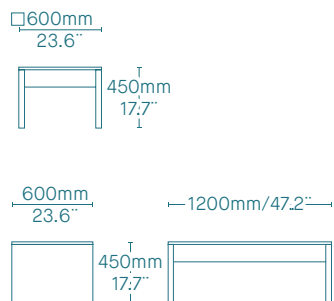

### Table top

Thickness	Shape	Finishes
19mm 0.9"		Wood Lacquer

### Structure

Shapes	Finishes
	Laminated





# AVANT

## TECHNICAL PRESENTATION

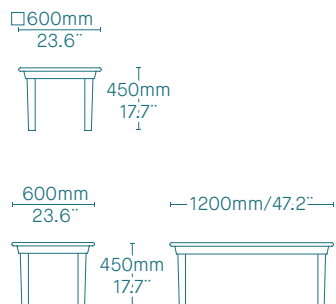
### Dimensions



### Table top

Thickness	Shape	Finishes
 19mm 0.9"	 	Wood

### Structure

Shapes	Finishes
	Textured lacquer





# HELIUM

## TECHNICAL PRESENTATION

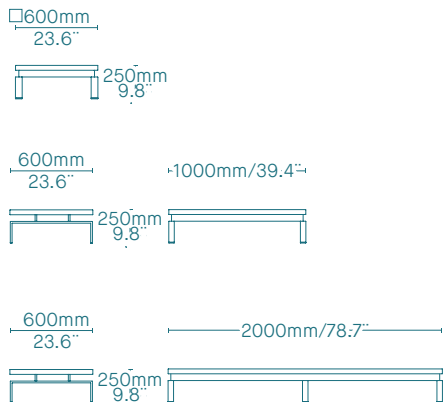
### Dimensions



### Table top

Thickness	Shape	Finishes
35mm 1.4"		Wood Lacquer
		

### Structure

Shapes	Finishes
	Chromed

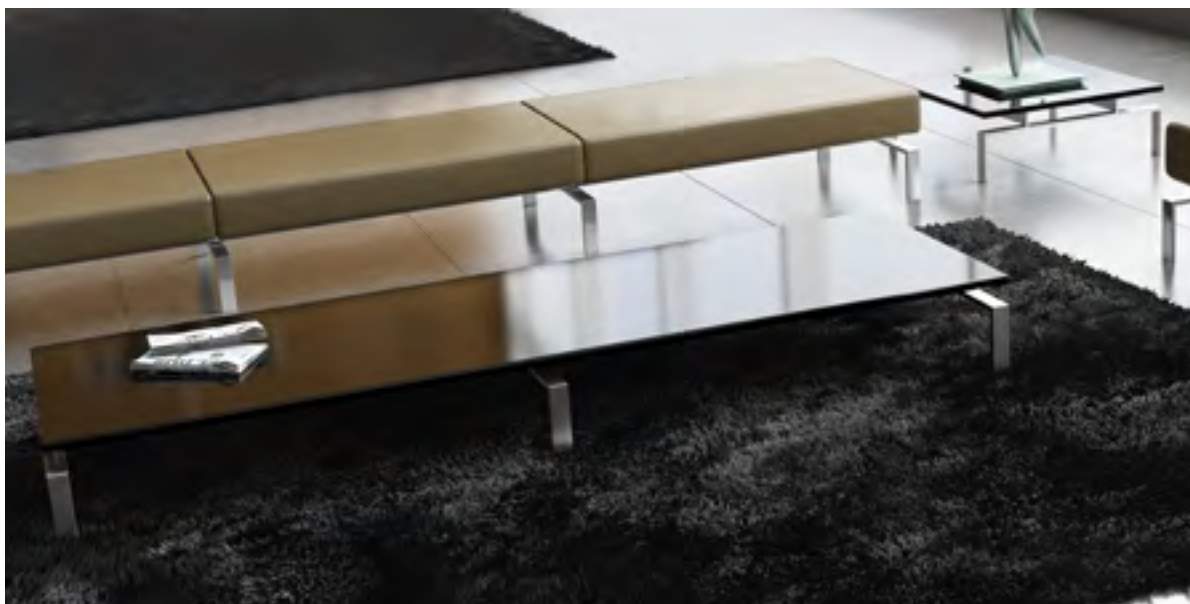

## OCCASIONAL TABLES FINISHES

### Natural wood veneers

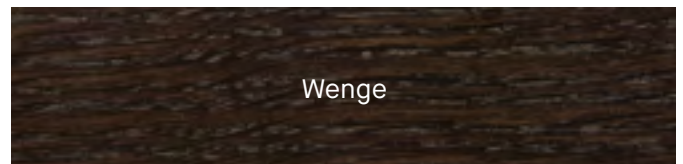
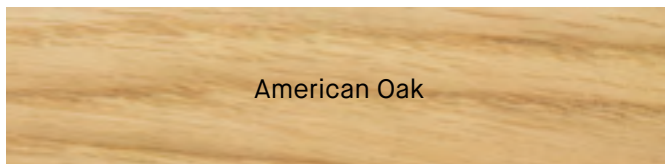
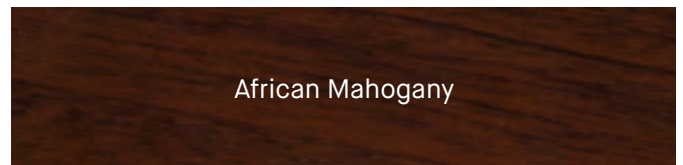
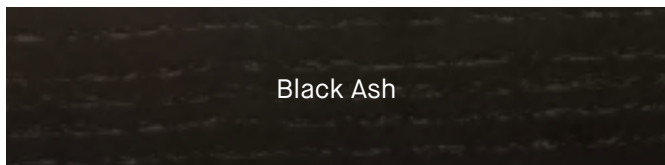
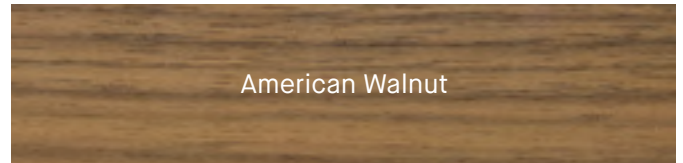
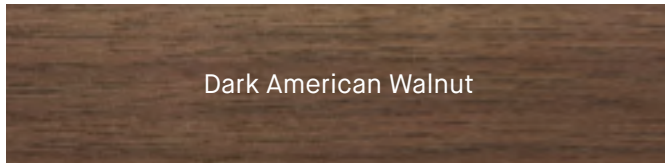
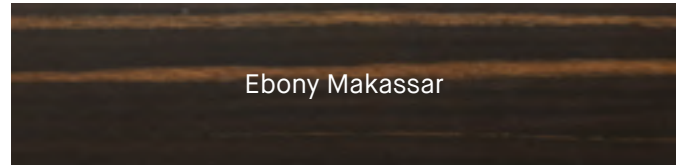

### Lacquer finishes

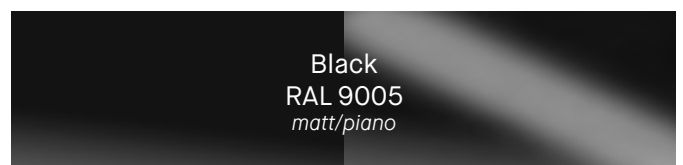

**OCCASIONAL TABLES**  
**FINISHES**

leather

Full Grain Leather - serie 900 - *Category Leather*

979	949	929
913	916	902
907	954	939
911	947	927
967	937	941
942	909	920
930	945	922
904	914	925
900	935	943
908	944	912
903		

Natural Leather - serie 100 - *Category Leather*

179	136	126
131	142	117
113	127	121
197	125	103

Eco leather - Valencia - *Category FAB1*

8032	1048	1049
1001	0002	9001
4001	1050	0035
2020	6019	0033
6012	2075	2062
5001	5069	0020
3001	3069	3067
4040	4002	4045
4043	4041	4003
		9035

Eco leather - Chronos - *Category FAB2*

0001	0002	0003
0008	0004	0007
0005	0006	0009
0013	0011	0010
0018	0019	0020

Eco leather - Polaris - *Category FAB2*

3393	3635	4712
3895	4714	3664
GZ96	2070	2938
3540	3663	3685
2774	2862	565



Diagonal 456  
08006 Barcelona (Spain)

T +34 932 370 942  
info@bos1964.com

 [bosbarcelona.com](https://www.bosbarcelona.com)

 Instagram  
[@bosbarcelona](https://www.instagram.com/bosbarcelona)

 Facebook  
[/bos1964](https://www.facebook.com/bos1964)

 LinkedIn  
[Bos Barcelona](https://www.linkedin.com/company/Bos-Barcelona)

 Pinterest  
[/bos1964](https://www.pinterest.com/bos1964)

 Youtube  
[BOS Barcelona](https://www.youtube.com/BOS-Barcelona)